



iCON iCS50



SCAN ME FOR INFO

iCON iCS50 Robotic Templater

Case Study - Commercial Van

New Carpet

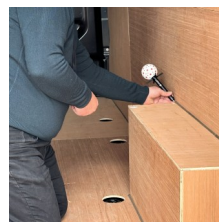
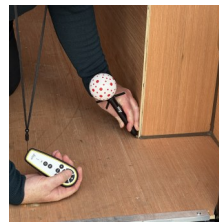
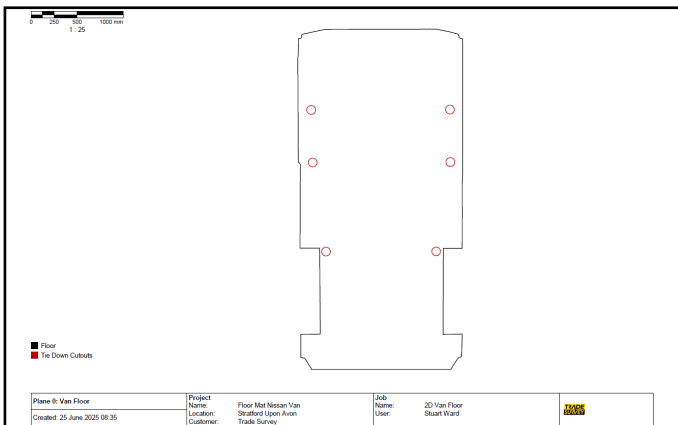
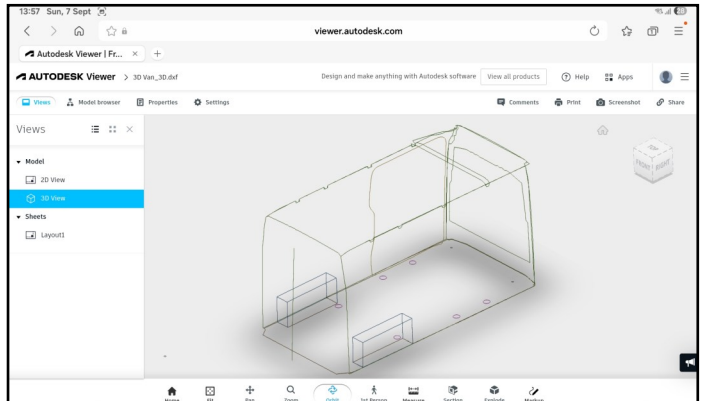
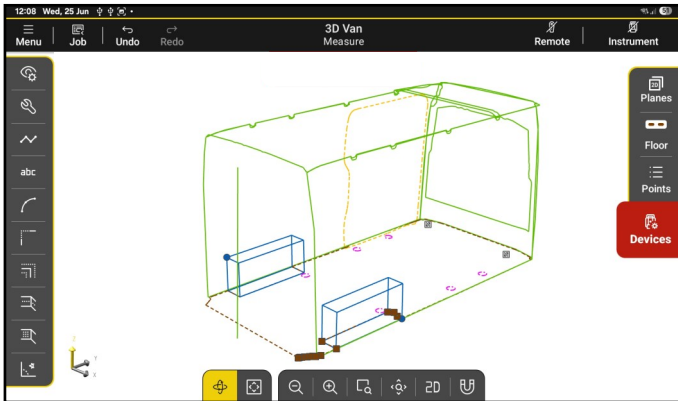

- when it has to be **right**

Leica
Geosystems



0800 292 2188 | SALES@TRADESURVEY.CO.UK | TRADESURVEY.CO.UK



iCON iCS50



SCAN ME FOR INFO

iCON iCS50 Robotic Total Station

Case Study - Curved Wall Cladding

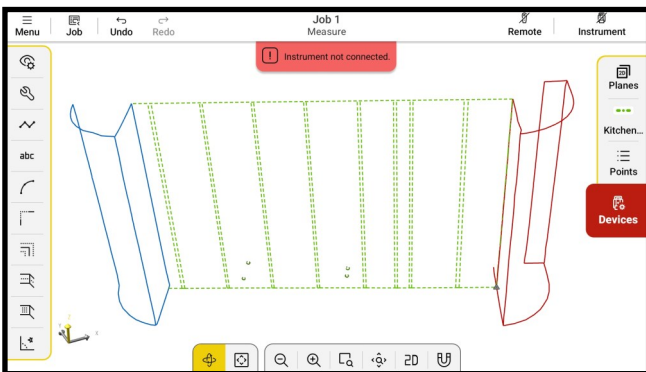
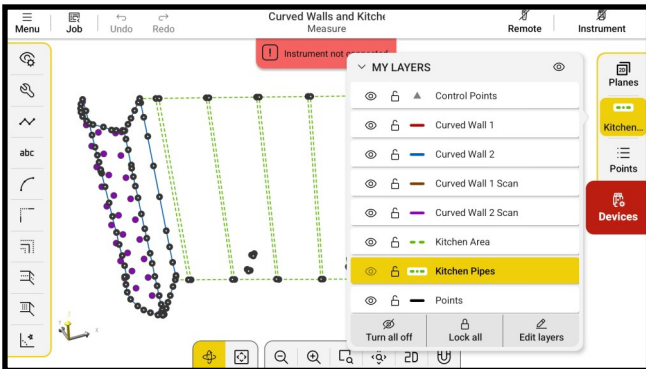
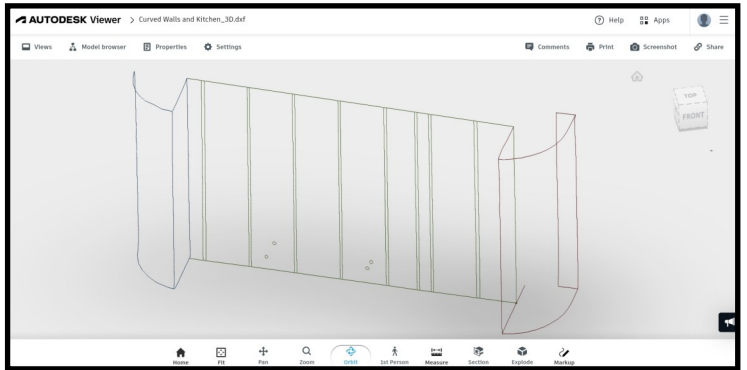
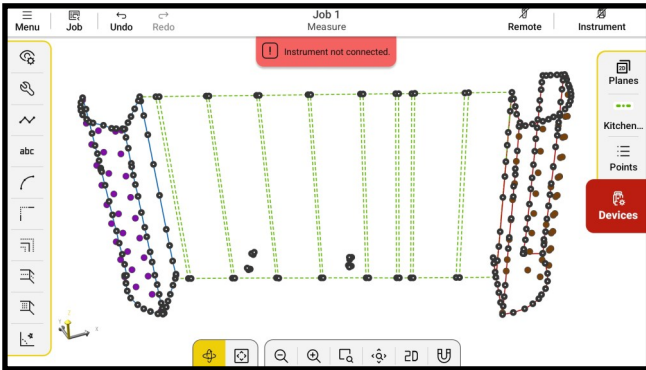

- when it has to be **right**



0800 292 2188 | SALES@TRADESURVEY.CO.UK | TRADESURVEY.CO.UK



iCON iCS50



SCAN ME FOR INFO

iCON iCS50 Robotic Templater

Case Study - Staircase & Landing

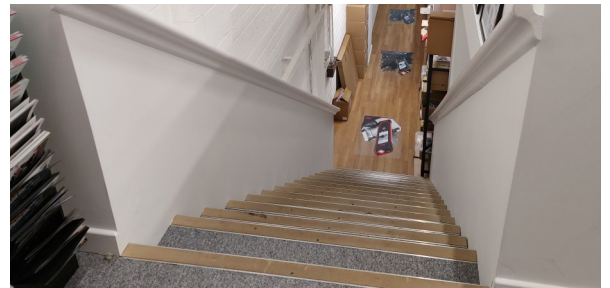
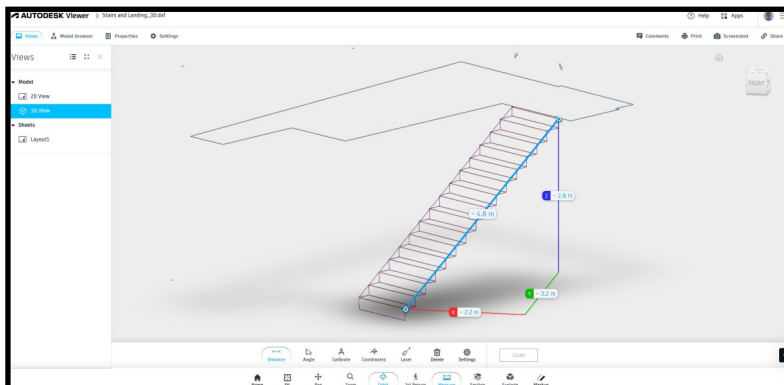
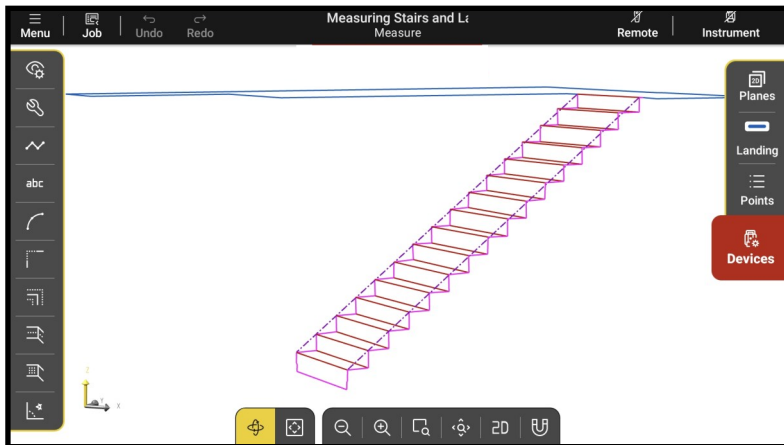
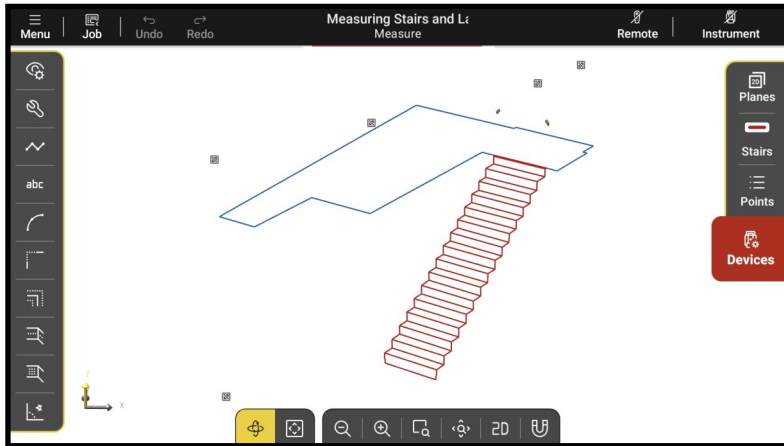

- when it has to be right



0800 292 2188 | SALES@TRADESURVEY.CO.UK | TRADESURVEY.CO.UK



iCON iCS50



SCAN ME FOR INFO

iCON iCS50 Robotic Templater

Case Study - Corner Office & Stairs

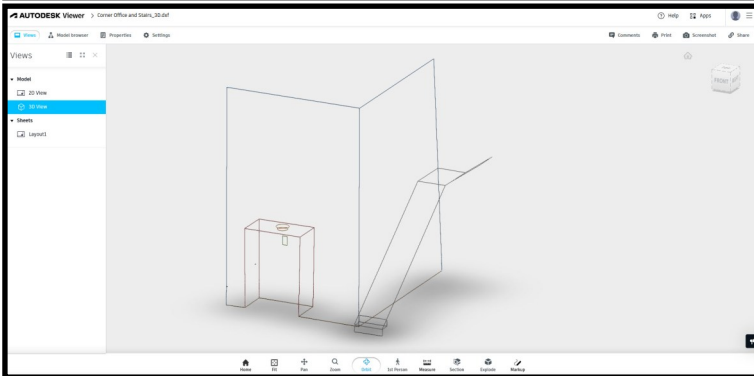
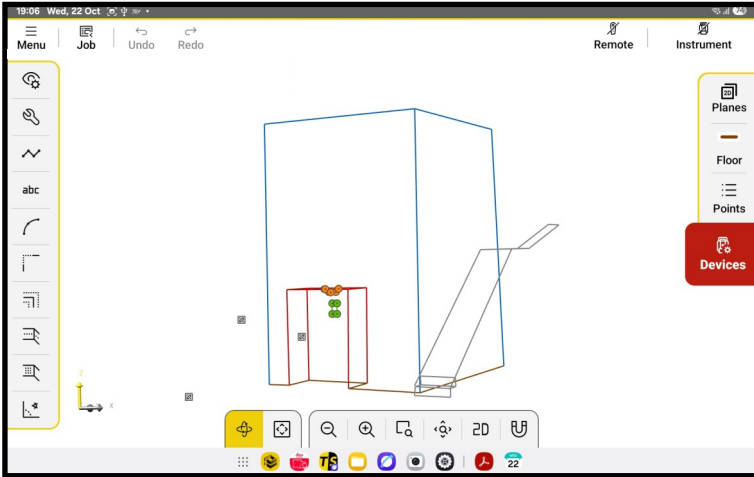

- when it has to be **right**

Leica
Geosystems



0800 292 2188 | SALES@TRADESURVEY.CO.UK | TRADESURVEY.CO.UK



iCON iCS50



SCAN ME FOR INFO

iCON iCS50 Robotic Templater Case Study - Office Fit-Out

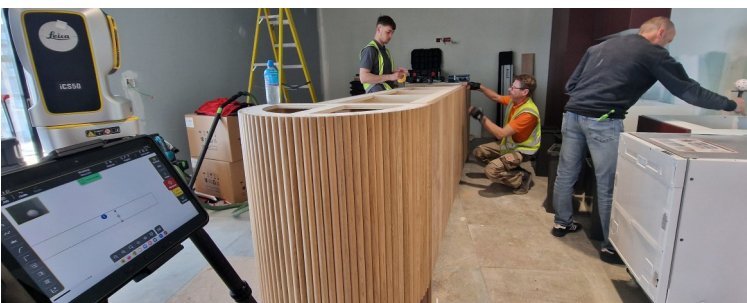
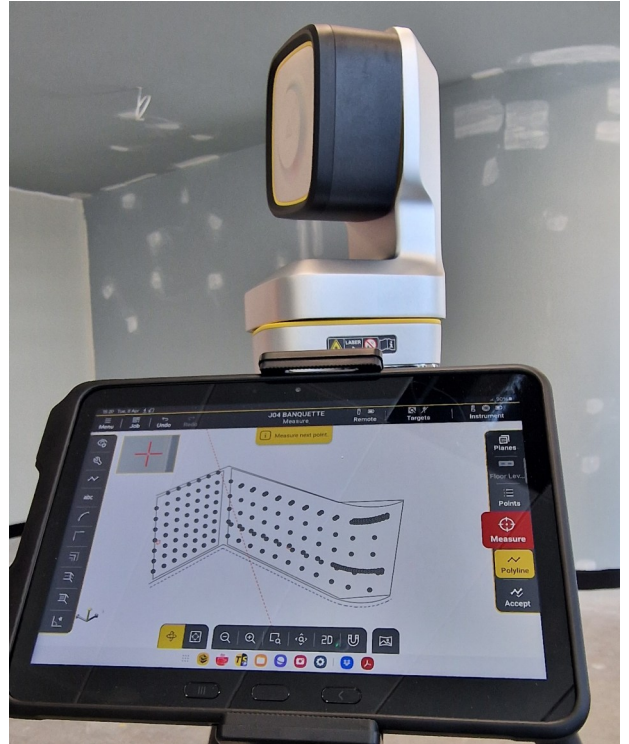

- when it has to be **right**

Leica
Geosystems

**TRADE
SURVEY**

0800 292 2188 | SALES@TRADESURVEY.CO.UK | TRADESURVEY.CO.UK



iCON iCS50



SCAN ME FOR INFO

iCON iCS50 Robotic Templater

Case Study - Video Screen Layout

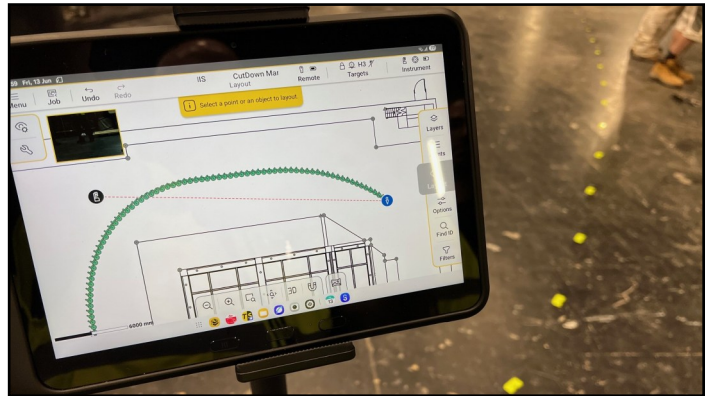
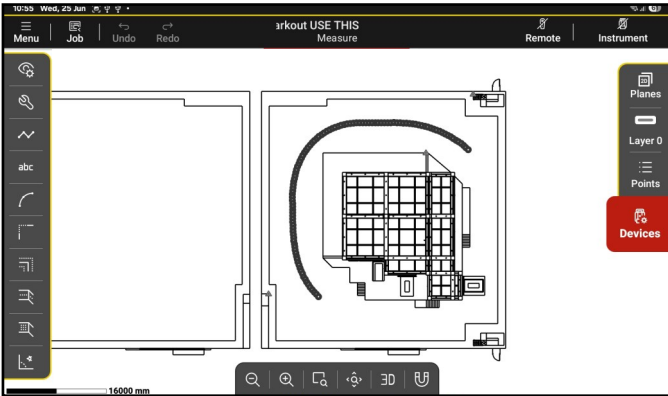

DASHBOARD

LAI D OUT POINTS

● Within tolerance 108

● Out of tolerance 0

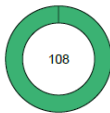

TO-DO LIST

● Within tolerance 0

● Out of tolerance 0

● To-do 0

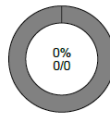

ID	Layout status	Layer	X (mm)	Y (mm)	Z (mm)	Δ Distance (mm)	Δ Height (mm)
P_001	✓	NONE	1767.0	3305.2	0.0	1.7	-39.5
P_002	✓	NONE	1768.8	2805.2	0.0	1.8	-40.7
P_003	✓	NONE	1770.7	2305.2	0.0	2.3	-41.1
P_004	✓	NONE	1772.5	1805.2	0.0	1.4	-40.5
P_005	✓	NONE	1774.3	1305.2	0.0	0.9	-39.8
P_006	✓	NONE	1776.2	805.2	0.0	1.7	-41.0

- when it has to be right



0800 292 2188 | SALES@TRADESURVEY.CO.UK | TRADESURVEY.CO.UK



iCON iCS50



SCAN ME FOR INFO

iCON iCS50 Robotic Templater

Case Study - Doors, Windows & Glass

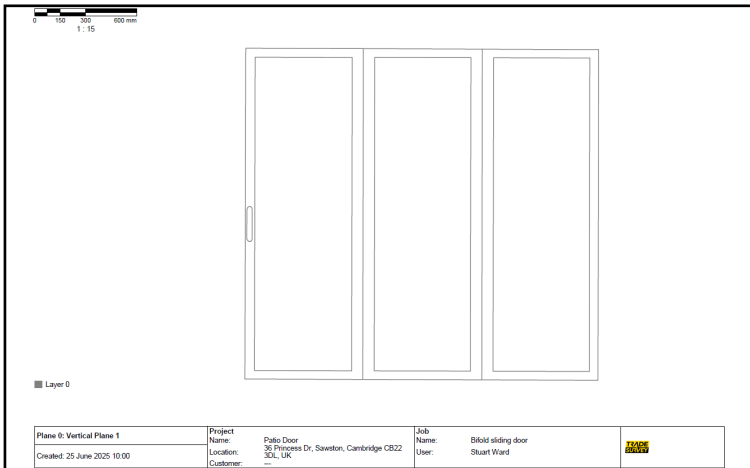
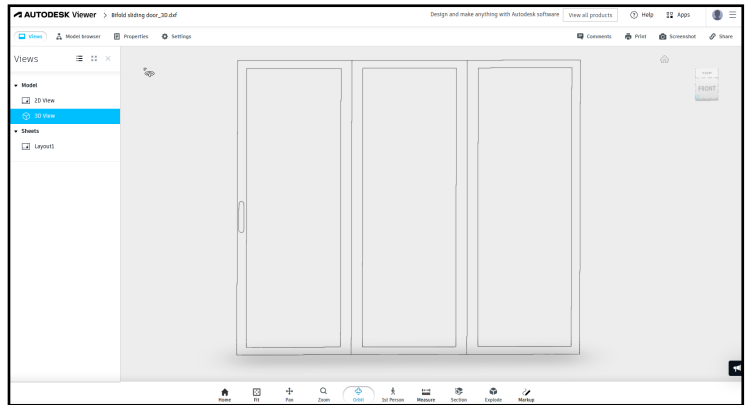
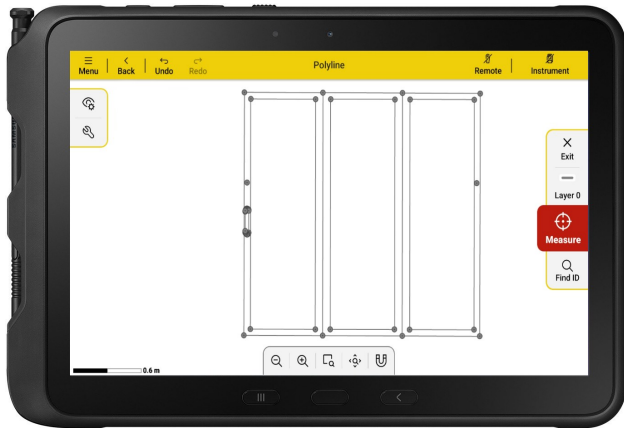

- when it has to be **right**



0800 292 2188 | SALES@TRADESURVEY.CO.UK | TRADESURVEY.CO.UK



iCON iCS50



SCAN ME FOR INFO

iCON iCS50 Robotic Templater

Case Study - Office Refurbishment

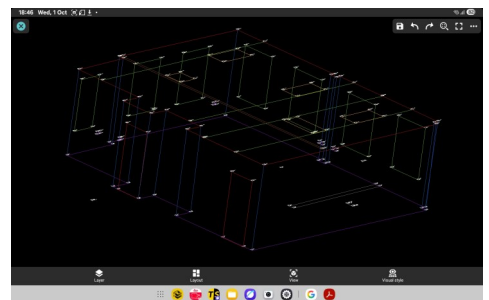
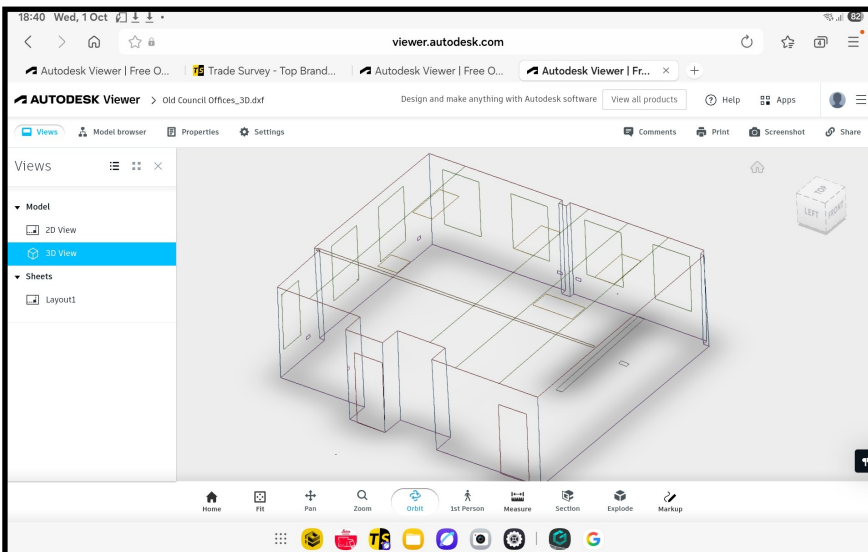
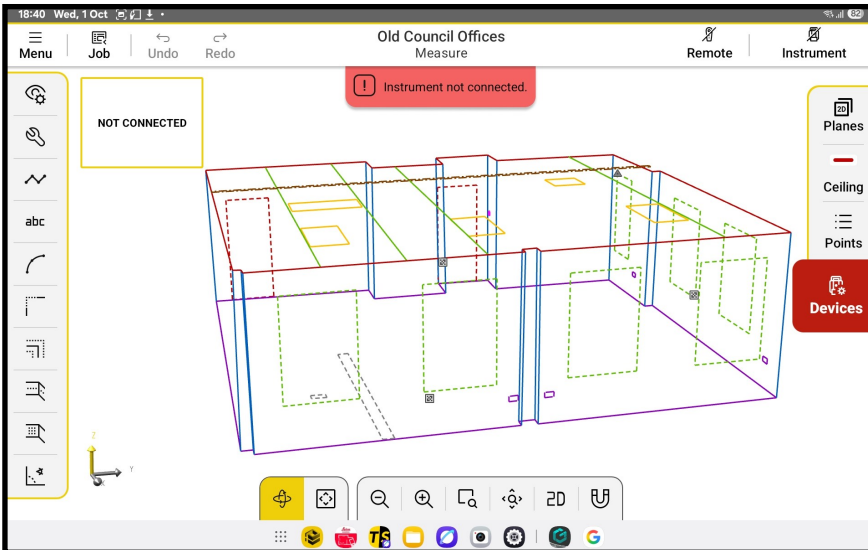

- when it has to be **right**



0800 292 2188 | SALES@TRADESURVEY.CO.UK | TRADESURVEY.CO.UK



iCON iCS50



SCAN ME FOR INFO

iCON iCS50 Robotic Templater

Case Study - Project Examples

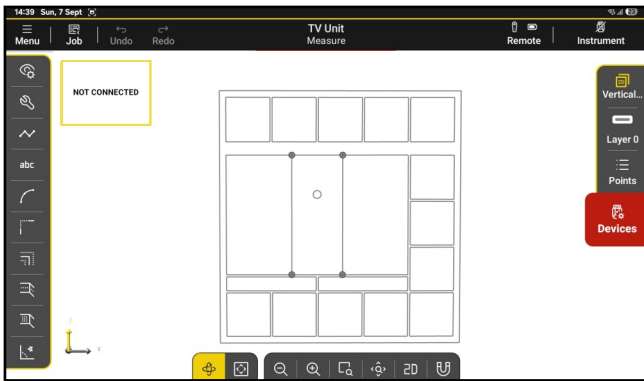

TV Cabinet

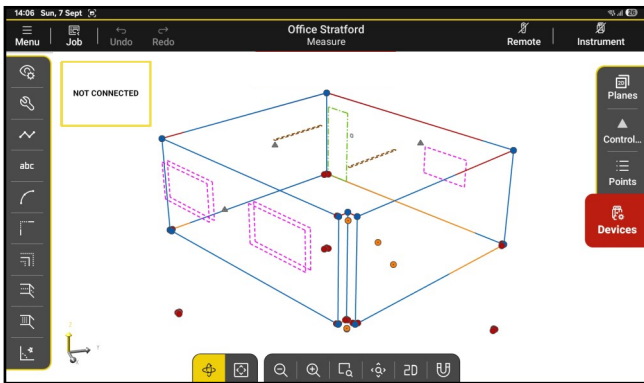
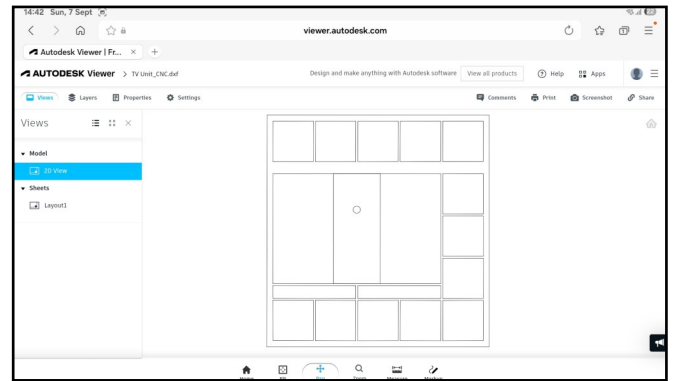

Office

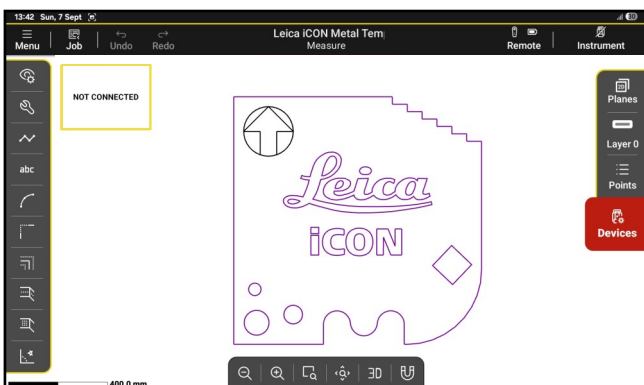
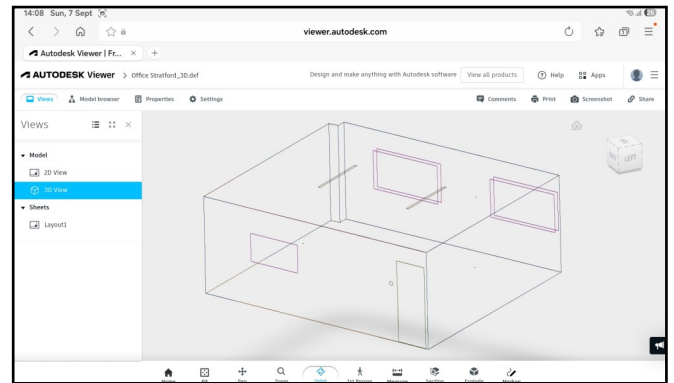

Metal Template

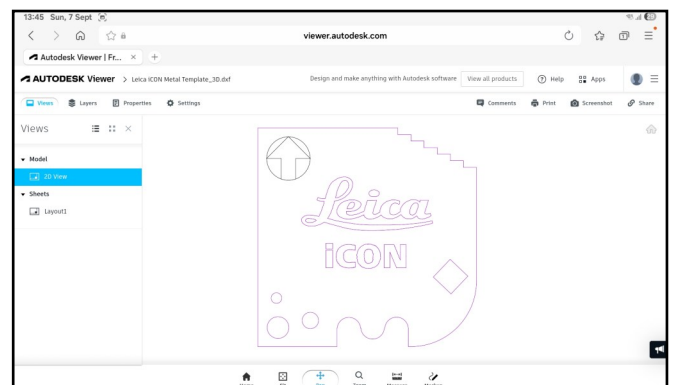

- when it has to be **right**



0800 292 2188 | SALES@TRADESURVEY.CO.UK | TRADESURVEY.CO.UK



iCON iCS50



SCAN ME FOR INFO

iCON iCS50 Robotic Templater

Case Study - Project Examples

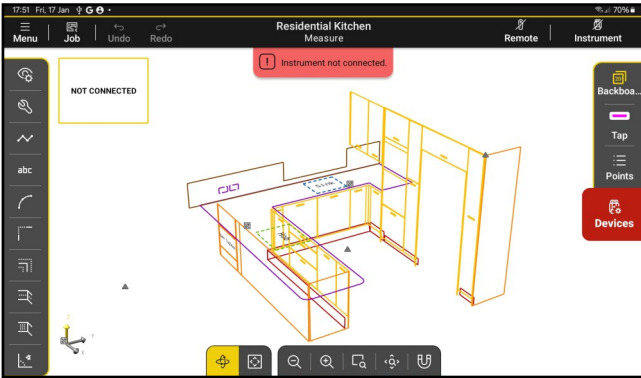

Kitchen

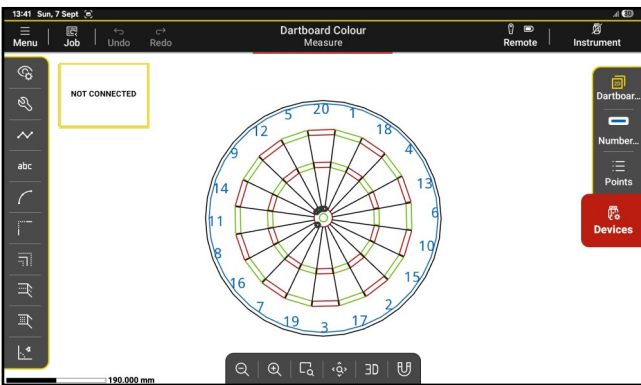
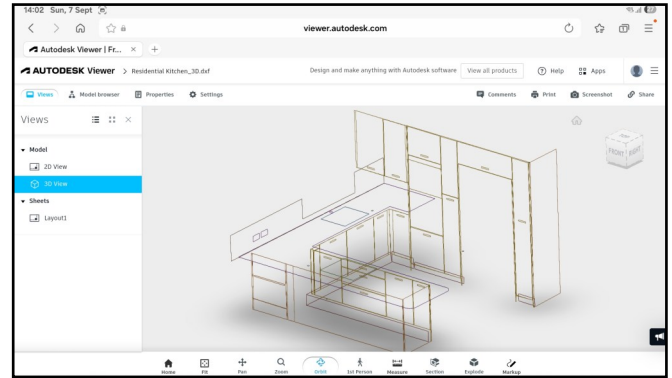

Dartboard

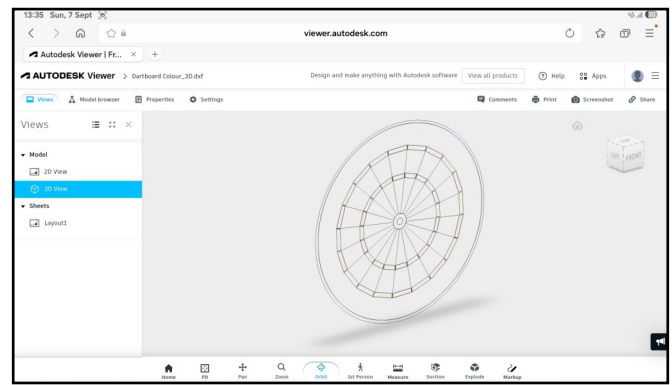

External Elevation of House

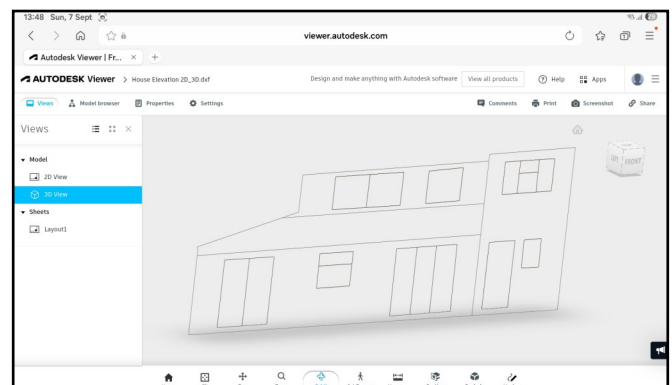

- when it has to be **right**



0800 292 2188 | SALES@TRADESURVEY.CO.UK | TRADESURVEY.CO.UK



iCON iCS50



SCAN ME FOR INFO

iCON iCS50 Robotic Templater Case Study - Project Examples

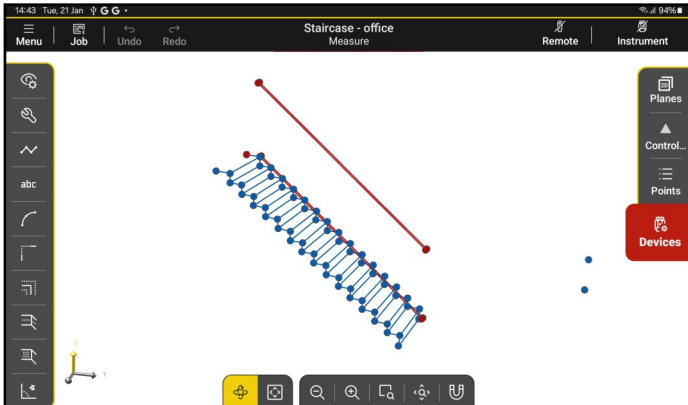

Staircase and Metal Balustrade

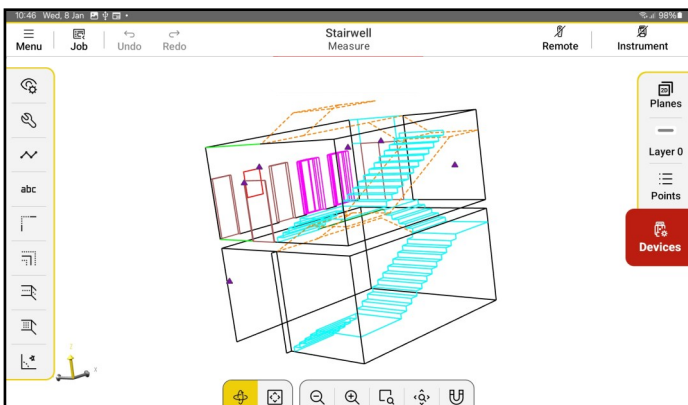
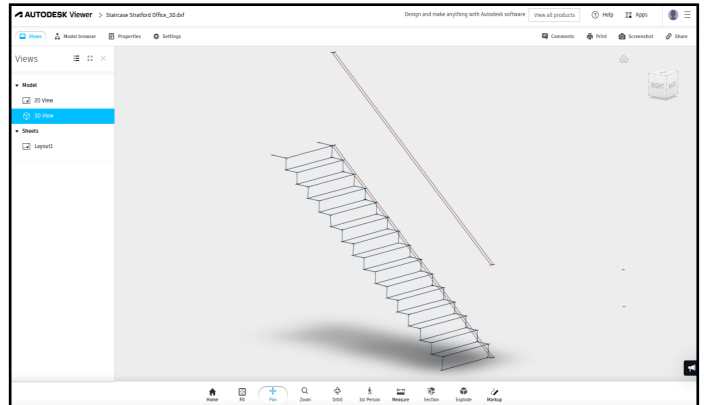

Stairwell

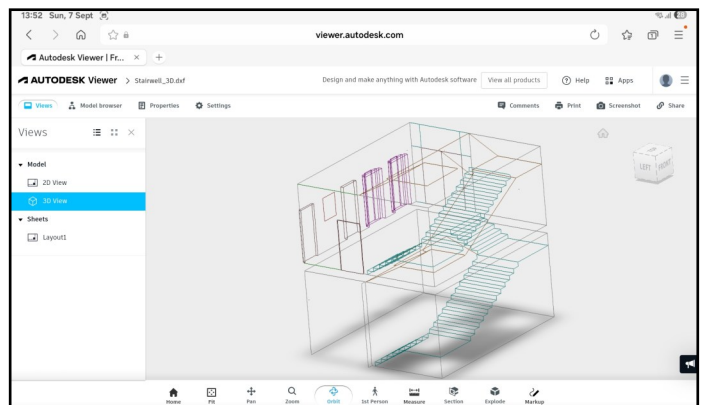

- when it has to be **right**



0800 292 2188 | SALES@TRADESURVEY.CO.UK | TRADESURVEY.CO.UK



ROBOTIC 3D PRECISION LASER TEMPLATER



iCON iCS50



SCAN ME FOR INFO



Yes, it's that simple

